

Assembly instructions - Eicon Wall 450

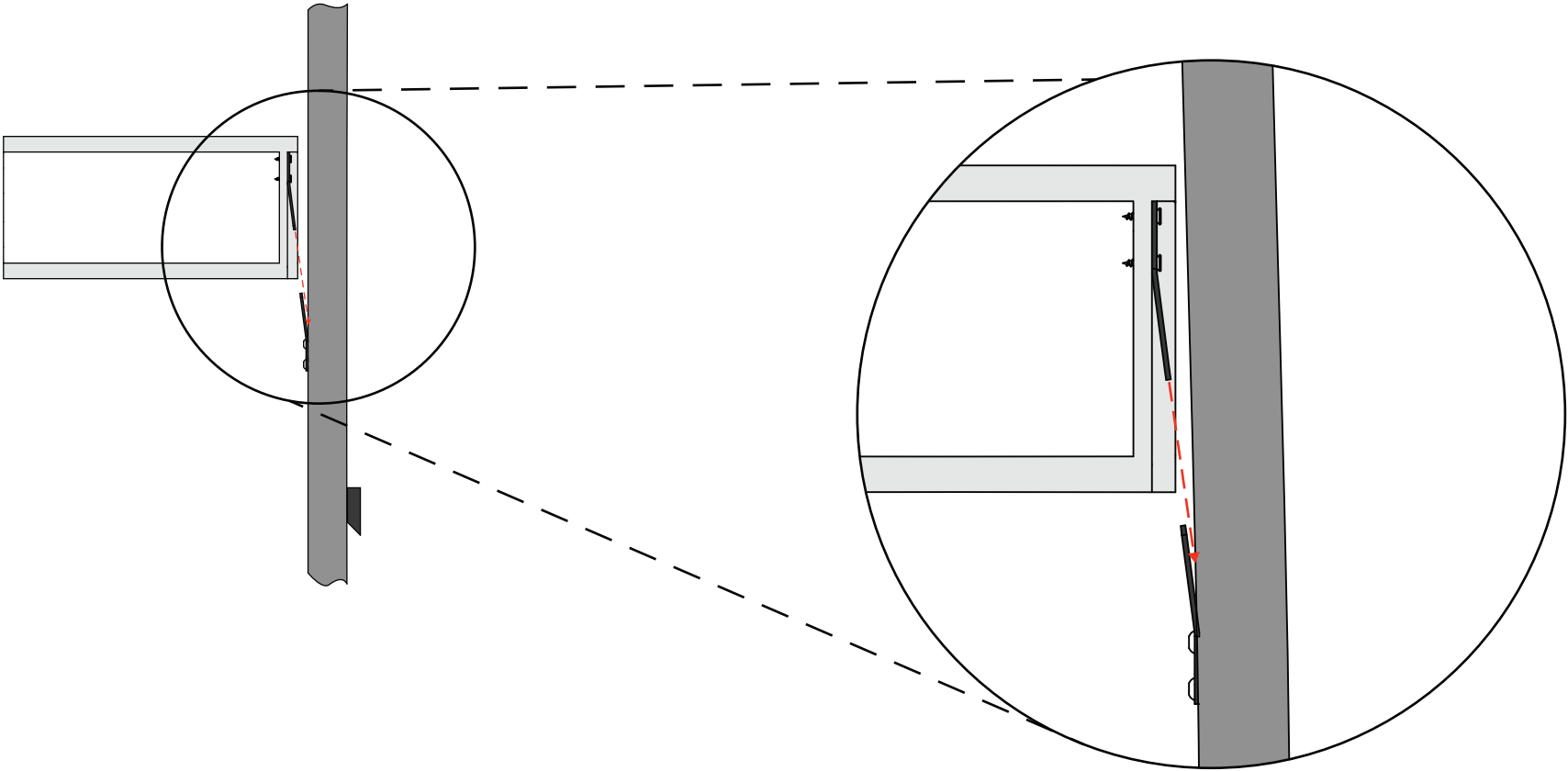
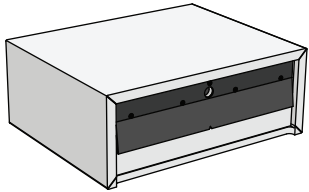
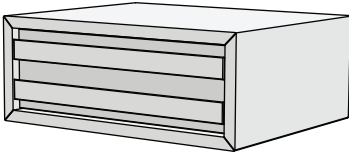

Designed for Sleep Comfort

Assembly instructions - Eicon Wall 450

Wall mount

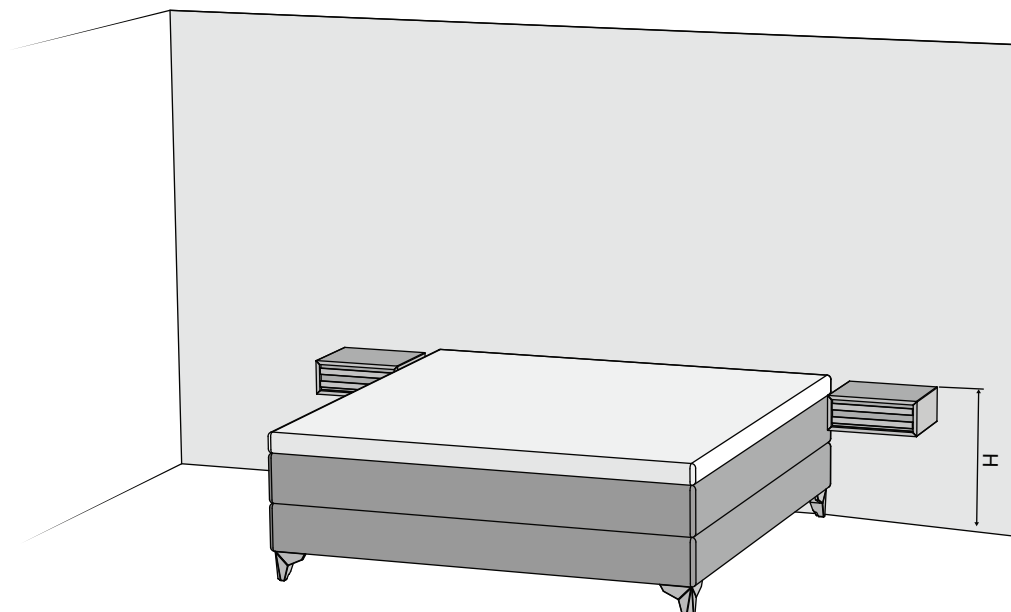
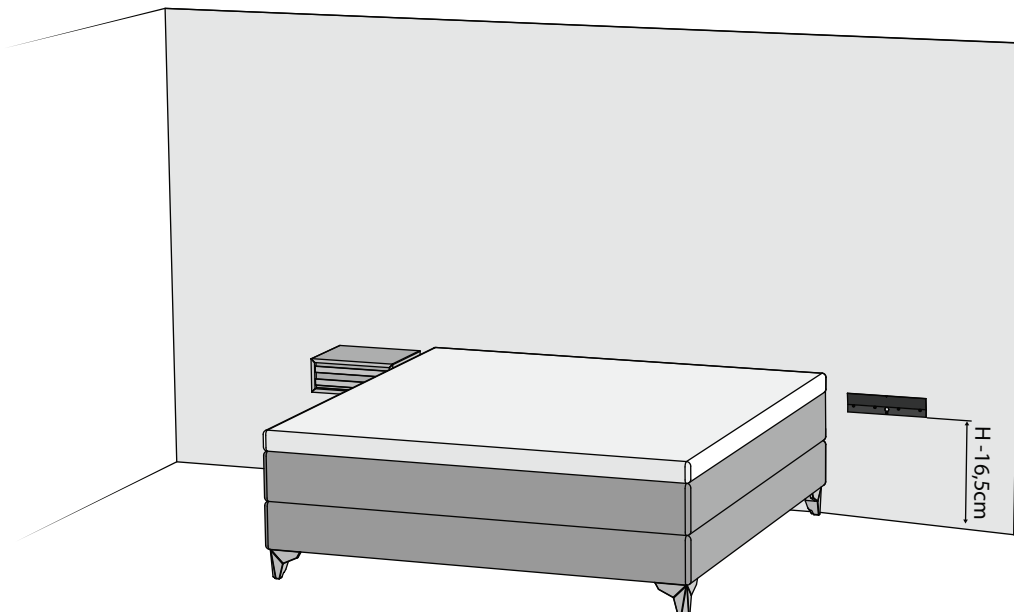
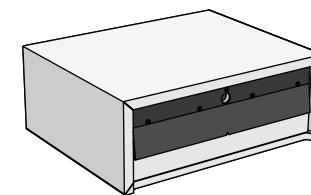
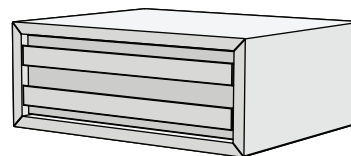

Screws to attach to the wall are not included.
Please contact a hardware or DIY store for advice on which ones to use.



Schrauben für die Wandmontage werden nicht mitgeliefert.
Wenden Sie sich zur Beratung bezüglich der passenden Schrauben an ein Eisenwarengeschäft oder einen Baumarkt.



Les vis pour le montage mural ne sont pas fournies.
Pour faire le choix adéquat, veuillez demander conseil dans une quincaillerie ou un magasin de bricolage.



Viti per il montaggio a parete non incluse.
Per consulenza sul tipo corretto, rivolgersi ad un negozio di ferramenta o faidaté.



Schroeven voor montage aan de muur worden niet bijgeleverd.
Neem voor advies over de juiste keuze contact op met een ijzerwarenhandel of een bouwmarkt.



Śruby do zamontowania na ścianie nie są dostarczone wraz z zestawem.
W celu uzyskania porady na temat właściwych śrub należy się skontaktować ze sklepem z narzędziami albo marketem budowlanym.



Os parafusos para fixação na parede não estão incluídos. Dirija-se a uma loja de ferragens ou de bricolagem para obter aconselhamento sobre o material a utilizar.



No están incluidos los tornillos para sujetarla a la pared. Por favor, póngase en contacto con una ferretería o con una tienda de bricolaje para que le aconsejen cuáles usar.



Seinäkiinnitysruuveja ei ole mukana.
Neuvoja ja valintoja saat laitevalmistajalta tai rakennustarvikeliikkeestä.



Skravar för väggmontering medföljer inte.
För råd och alternativ, kontakta en järnvaruhandel eller ett byggvaruhus.



Skruer til veggmontering følger ikke med. For råd og valg ta kontakt med en jernvareforhandler eller byggevarehus.



Skruer til vægmontering er ikke inkluderet. For råd og bedes du kontakte enforhandler eller et byggemarked.



Designed for Sleep Comfort